

## INSTRUCTION MANUAL

# Orion® StarSeeker™ IV GoTo Telescopes

#13159 StarSeeker IV 114mm Reflector    #13162 StarSeeker IV 102mm Mak-Cass

#13160 StarSeeker IV 130mm Reflector    #13163 StarSeeker IV 127mm Mak-Cass

#13161 StarSeeker IV 150mm Reflector    #13164 StarSeeker IV 80mm Refractor

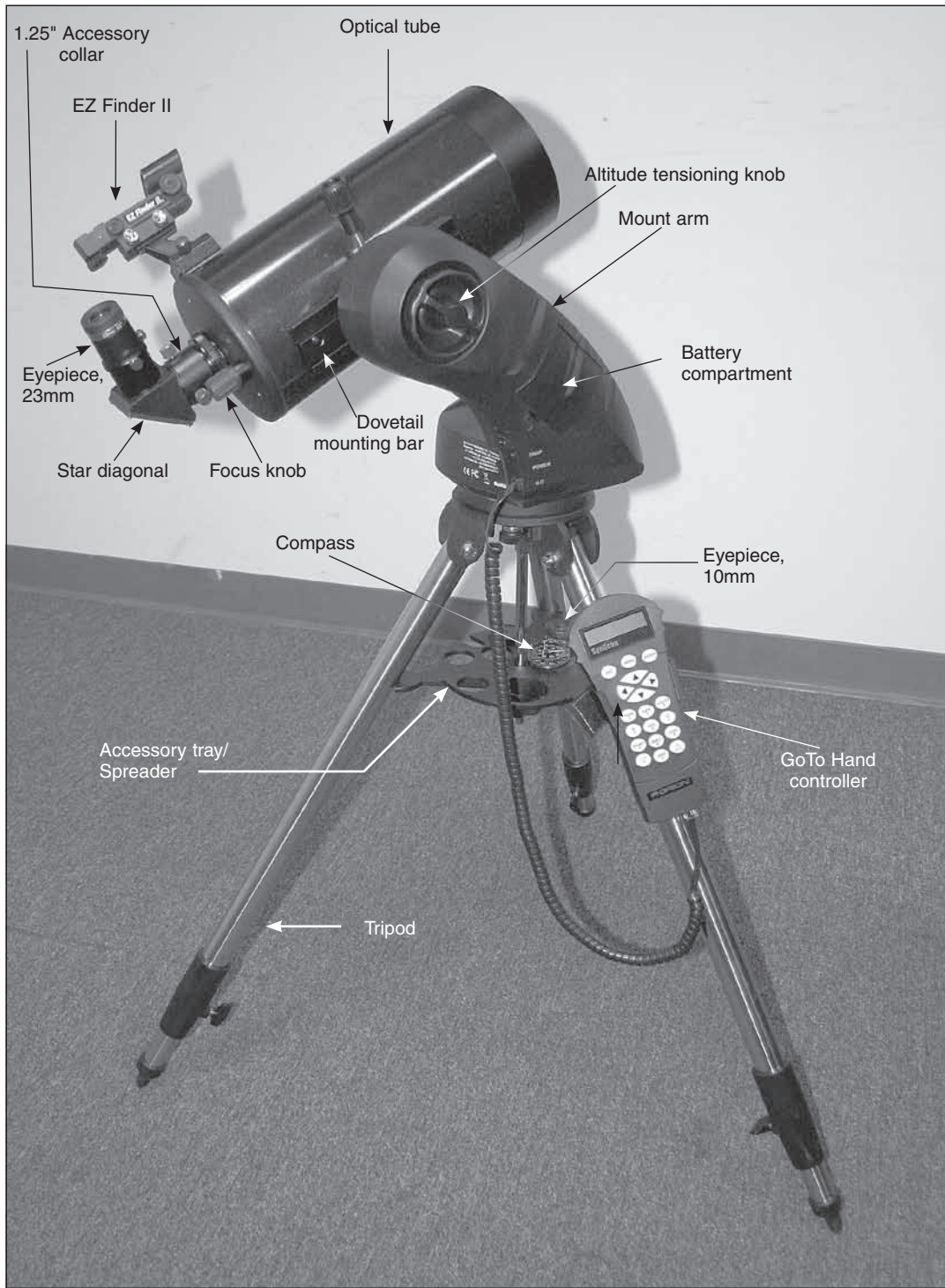
#13165 StarSeeker IV Mount with GoTo Hand Controller



#13161

 **ORION**  
TELESCOPES & BINOCULARS  
*Providing Exceptional Consumer Optical Products Since 1975*

*Customer Support:*  
[www.OrionTelescopes.com/contactus](http://www.OrionTelescopes.com/contactus)  
*Corporate Offices:*  
89 Hangar Way, Watsonville CA 95076 – USA



**Figure 1.** Parts of the StarSeeker IV (127mm Maksutov-Cassegrain shown)

# Table of Contents

<b>Introduction</b> .....	<b>3</b>
<b>Parts List</b> .....	<b>3</b>
<b>Assembly</b> .....	<b>4</b>
<b>Learning to Use the EZ Finder, Eyepieces, and Focuser</b> .....	<b>8</b>
The EZ Finder II .....	8
Eyepieces and Magnification .....	8
Focusing .....	9
Image Orientation .....	9
<b>Powering the StarSeeker IV Mount</b> .....	<b>10</b>
<b>The SynScan GoTo Hand Controller</b> .....	<b>10</b>
<b>Initial Setup</b> .....	<b>11</b>
<b>Moving the Mount</b> .....	<b>12</b>
<b>GoTo Star Alignment</b> .....	<b>12</b>
Brightest Star Alignment .....	13
2-Star Alignment .....	13
<b>Locating Objects</b> .....	<b>14</b>
SynScan's Object Database .....	14
Selecting an Object .....	14
Take a Guided Tour! .....	14
Select Using the Object Type Shortcut Keys .....	14
Select Using the Object or Menu Shortcut Keys .....	14
Identifying an Unknown Object .....	14
<b>Other Features &amp; Functions</b> .....	<b>15</b>
Utility Functions .....	15
Setup Functions .....	15
Updating Firmware .....	15
<b>Collimation of StarSeeker IV Reflectors</b> ....	<b>15</b>
<b>Appendix A – SynScan Menu Tree</b> .....	<b>17</b>
<b>Appendix B – Time Zone Map</b> .....	<b>18</b>
<b>Appendix C – Sky Maps (for selection of alignment stars)</b> .....	<b>19</b>

**WARNING:** *Never look directly at the Sun with the naked eye or with a telescope – unless you have a proper solar filter installed over the front of the telescope! Otherwise, permanent, irreversible eye damage may result.*

# Introduction

Congratulations on your purchase of an Orion StarSeeker IV GoTo telescope! Simple and friendly to use, the StarSeeker combines state-of-the-art GoTo pointing technology with sharp optics in a portable package that makes observing the night sky both remarkably easy and wonderfully rewarding.

This manual covers a variety of different StarSeeker models. Some sections may be specific to a particular type of telescope, but most apply generally to features and procedures common to all of the telescopes.

Take time to read through this manual before embarking on your journey through the heavens. It may take a couple of observing sessions to become familiar with all of the StarSeeker's features. The StarSeeker's hand controller displays step-by-step instructions to guide you through the alignment procedures needed to get the telescope up and running in minutes. Use this manual in conjunction with the on-screen instructions provided by the hand controller. The manual gives detailed information regarding each step as well as needed reference material and helpful hints guaranteed to make your observing experience as easy and pleasurable as possible.

# Parts List

## Qty. Description

- 1 Optical tube assembly
- 1 Mount arm
- 1 Tripod
- 1 Accessory tray
- 1 GoTo hand controller
- 1 Hand controller cable
- 1 Hand controller holder
- 1 EZ Finder II reflex sight (with bracket)
- 1 23mm widefield 60-degree eyepiece
- 1 10mm widefield 60-degree Eyepiece
- 1 Star diagonal, 1.25" (Mak-Cass and Refractor models only)
- 1 Quick-collimation Cap (Reflector models only)
- 1 Objective Cover
- 1 2mm Allen wrench (Reflector models only)
- 1 Serial RS-232 cable
- 1 DC power cable
- 1 Compass
- 1 Starry Night Software digital download insert
- 1 L-bracket (#13165 mount only)
- 1 Camera shutter control (SNAP) cable (#13165 mount only)



**Figure 2.** Included components of the StarSeeker IV GoTo telescope. (StarSeeker IV 127mm Mak-Cass shown)

Open the shipping box and, referring to the above Parts List and **Figure 2**, check that all the parts are present. Remove all of the accessories from their individual boxes and bags. Remember to save all of the original packaging in case the scope needs to be returned to Orion for warranty repair, or should you wish to return the scope under the 30-day return policy. Especially in the latter case, the original packaging is required. If anything is missing, contact Orion Customer Service at (800) 676-1343, or support@telescope.com.

## Assembly

### Setting Up the Tripod and Mount arm

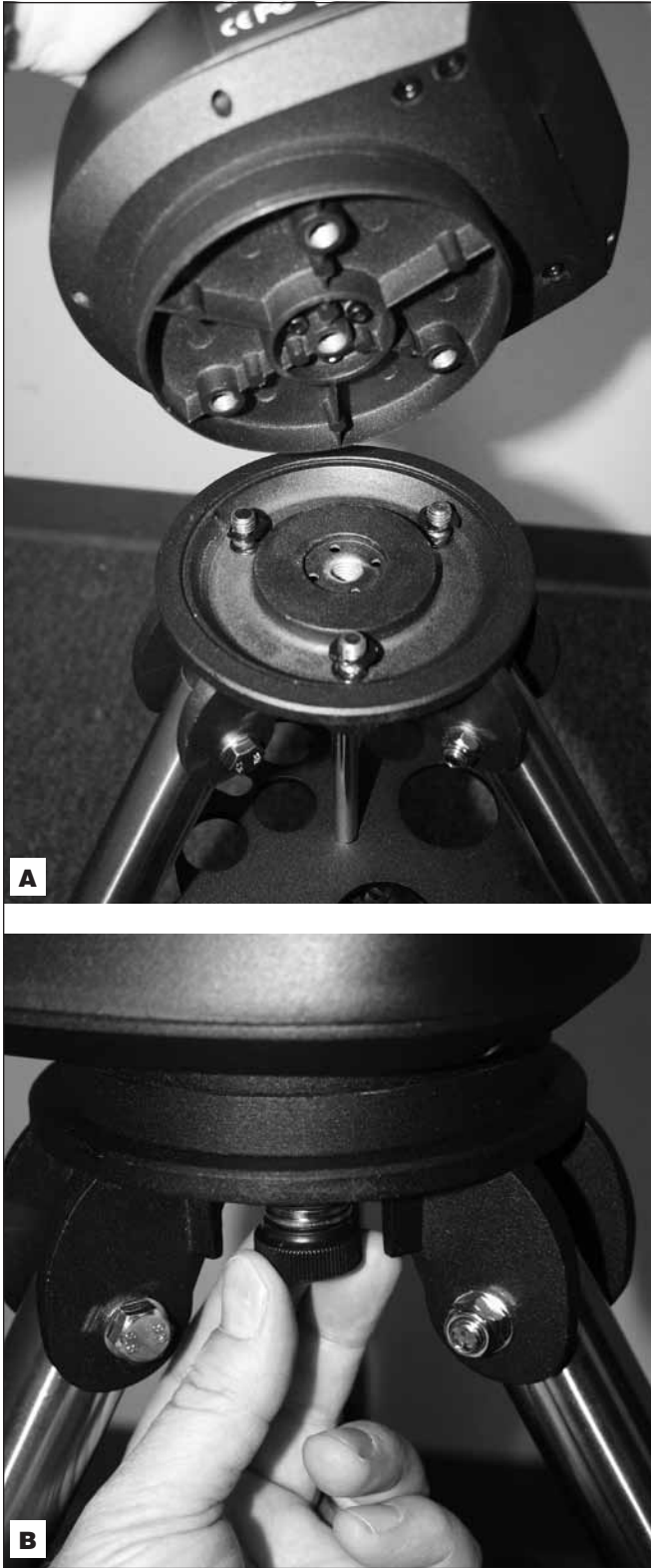
1. Stand the tripod legs upright and spread the legs out as wide as they will go.
2. Remove the knob and washer from the bottom of the tripod's center support shaft. Slide the tripod support tray up onto the shaft; the flat side of the support tray should be facing up. Make sure the "V" of each tray arm is against a tripod leg. Place the washer on the center support shaft against the tray, then thread the knob back onto the shaft until tight (**Figure 3**). The tripod support

tray provides additional stability for the tripod, and has holes for eyepieces and other accessories..

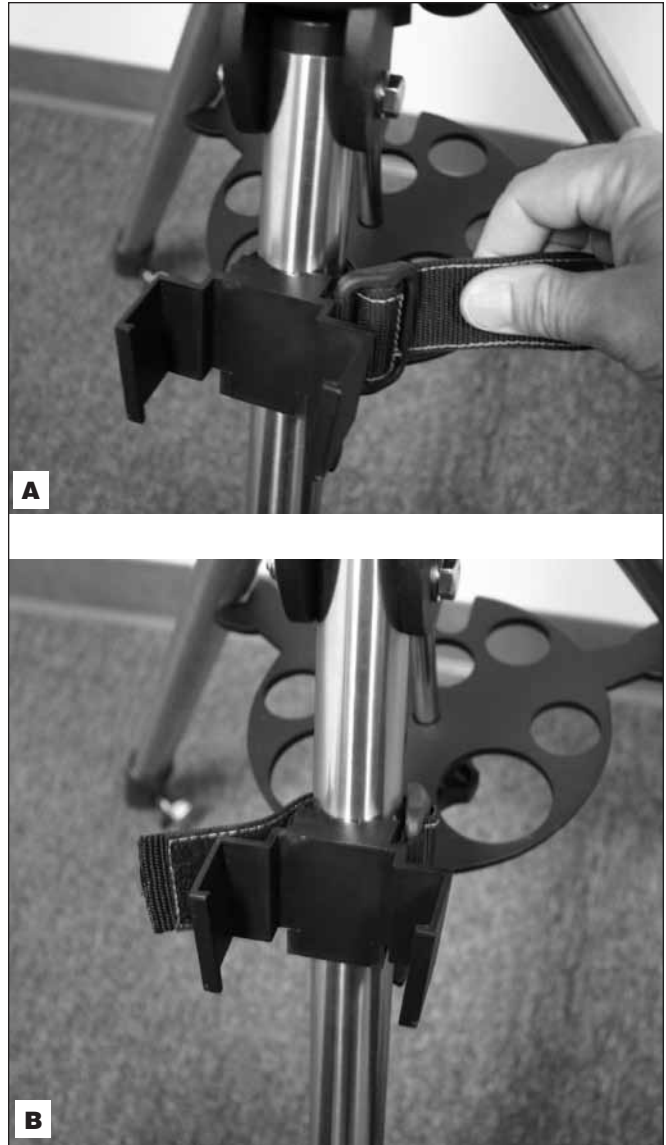


**Figure 3.** Install the accessory tray/tripod spreader before attaching the mount arm.

3. Place the base of the mount arm onto the tripod's top plate, lining up the three holes in the bottom of the arm base with the three bolts in the top plate (**Figure 4A**). Turn the three knobs under the tripod top plate clockwise until tight (**Figure 4B**).



**Figure 4.** The mount arm attaches to the tripod mounting platform with three captive bolts. **A)** Line up the bolts with the holes in the bottom of the arm base. **B)** Tighten the three knobs.



**Figure 5.** **A)** Wrap the strap around a tripod leg and pull tight before fastening. **B)** The hand controller bracket installed.

4. Attach hand controller bracket to a tripod leg. If you attach it above the accessory tray it will not be able to slide down the leg. See **Figure 5**.
5. To adjust the height of the tripod legs, loosen the tripod leg clamp knob located on the side of each leg (**Figure 6**). Extend the inner portion of each leg to the desired length. Then tighten the tripod leg clamp knob to secure each leg in place.

**Attaching the Telescope Tube to the Mount Arm**

6. Unthread the tube lock knob until the bolt tip is not protruding into the saddle slot (**Figure 7**). Slide the telescope's dovetail bar into the saddle on the mount arm as shown and secure it by tightening the tube lock knob. Note that the tube lock knob can be positioned either

up or 180 degrees opposite in the down position, your choice.

Also notice the altitude axis tensioning knob near the top of the mount arm (refer to Figure 1). It is used to set the desired tension for rotation of the telescope by hand in altitude. Turn the knob clockwise to increase the tension; turn it counter-clockwise to decrease the tension. There is no tensioning knob for azimuth rotation

### ***Inserting the Star Diagonal (Mak-Cass and Refractor) and Eyepiece***

A star diagonal is used with the Maksutov-Cassegrain and refractor models to divert the light at a right angle from the light path of the telescope. This allows you to observe in positions that are more comfortable than if you were to look straight through the telescope. A diagonal is not used with Newtonian reflectors; none is included with the StarSeeker reflector models.

To attach the star diagonal:

1. Remove the protective dust cap from the 1.25" accessory adapter or focuser.
2. Loosen the two thumbscrews on the 1.25" adapter or focuser and slide the chrome portion of the star diagonal into it (see **Figure 8**). Then retighten the thumbscrews to hold the star diagonal in place.

The eyepiece is the optical element that magnifies the image focused by the telescope. The eyepiece fits directly into the 1.25" focuser (on reflector models) or star diagonal. To install one of the included eyepieces:

1. Loosen the two thumbscrews on the focuser's 1.25" accessory collar or the star diagonal, then slide the chrome barrel of the eyepiece into it (**Figure 9**).
2. Tighten the thumbscrews to hold the eyepiece in place.

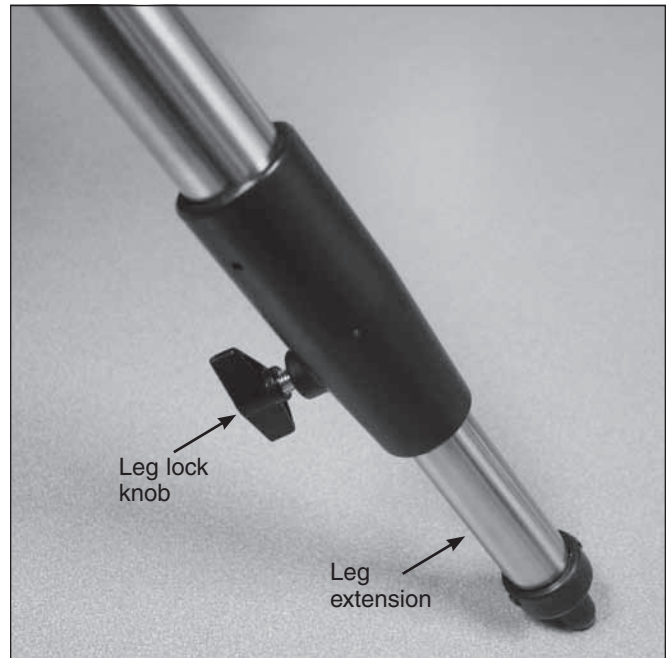
### ***Installing the EZ Finder II***

Before installing the EZ Finder II on the telescope, you will need to insert the included CR2032 3V lithium button cell battery in the EZ Finder II. If there is a small plastic tab sticking out from the battery compartment cover, you must remove it for the battery to make contact with the EZ Finder's electronic circuitry. The tab can then be discarded.

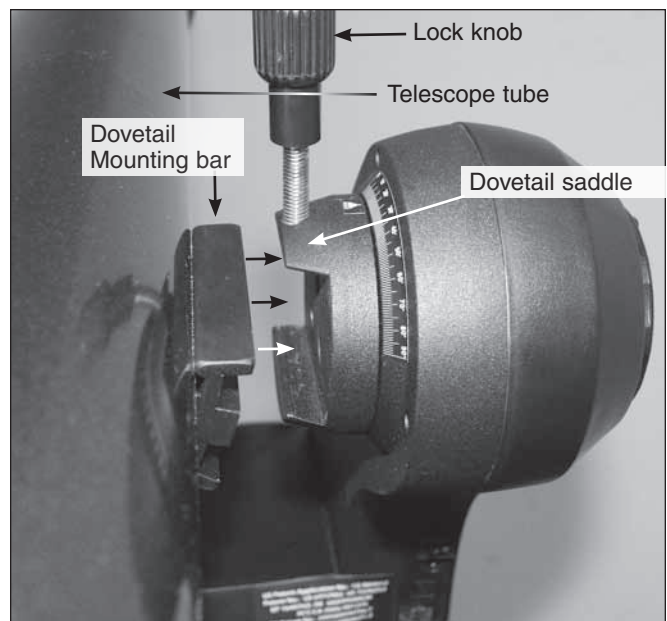
1. Turn the EZ Finder II upside down as shown in **Figure 10A**.
2. Insert a small, flat-blade screwdriver into the notch in the battery compartment cover and gently pry it off.
3. Slide the battery under the retaining clip with the positive (+) side facing up (touching the clip) (**10B**).
4. Then press the battery compartment cover back on.

Should the battery die, replacement CR2032 batteries are available at many stores where small batteries are sold or online.

5. To attach the dovetail mounting bracket to the EZ Finder II, loosen the two thumbscrews on the bottom rail of the EZ Finder II. Slide the EZ Finder II onto the bracket and tighten the two thumbscrews (See **Figure 11**). Then



**Figure 6.** Loosen the leg clamp knob to adjust the length of the tripod legs.



**Figure 7.** The telescope tube can be attached and removed easily via the dovetail saddle on the mount arm.

simply slide the mounting bracket's foot into the dovetail mounting shoe as shown in **Figure 12** and tighten the thumbscrew on the shoe to secure the mounting bracket.

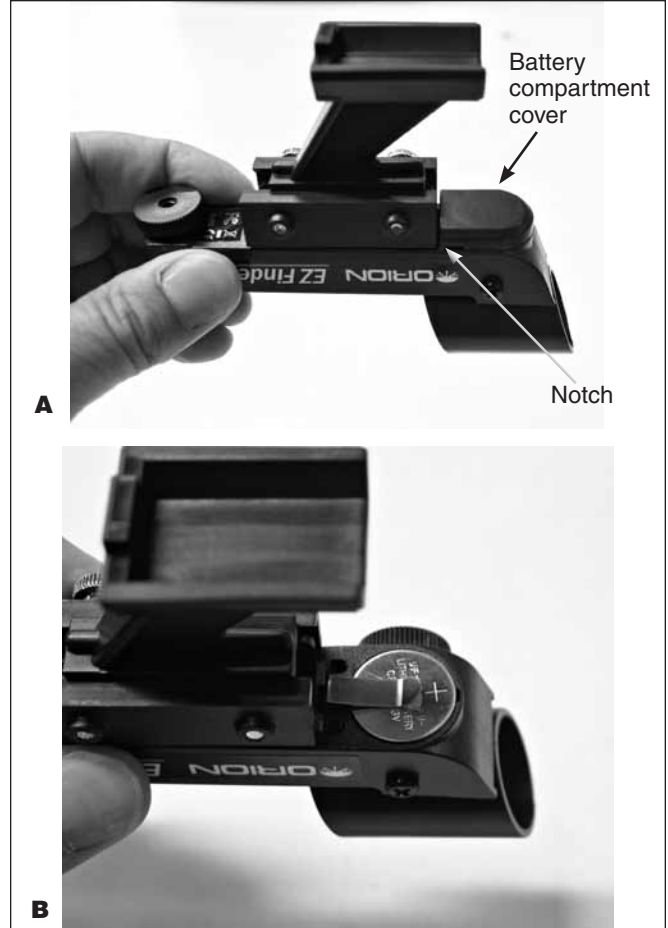
6. The EZ Finder II should be oriented so that the sight tube is facing the front of the telescope, as shown. Tighten the thumbscrew on the dovetail shoe to secure the EZ Finder II in place.



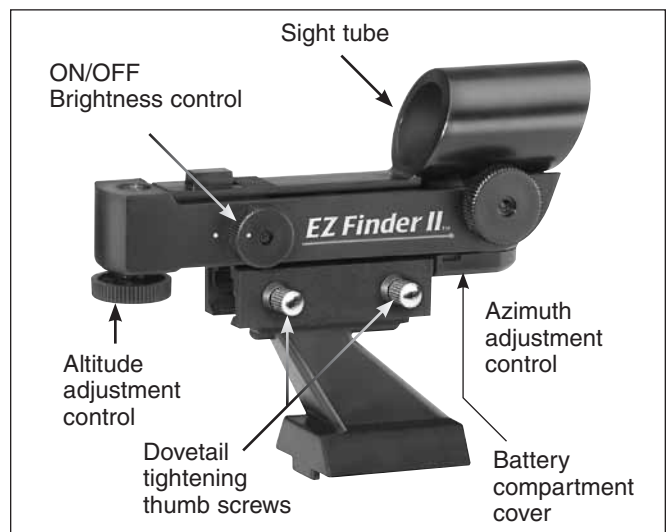
**Figure 8.** Attaching the star diagonal (refractor and Maksutov-Cassegrain models only).



**Figure 9.** Inserting an eyepiece into the diagonal of a Maksutov-Cassegrain. For reflector models the eyepiece is installed directly in the focuser's accessory collar.



**Figure 10.** A) To install the CR2032 battery in the EZ Finder II, first turn it upside-down and remove the battery compartment cover. B) Install the battery with positive (+) side facing up, as shown.



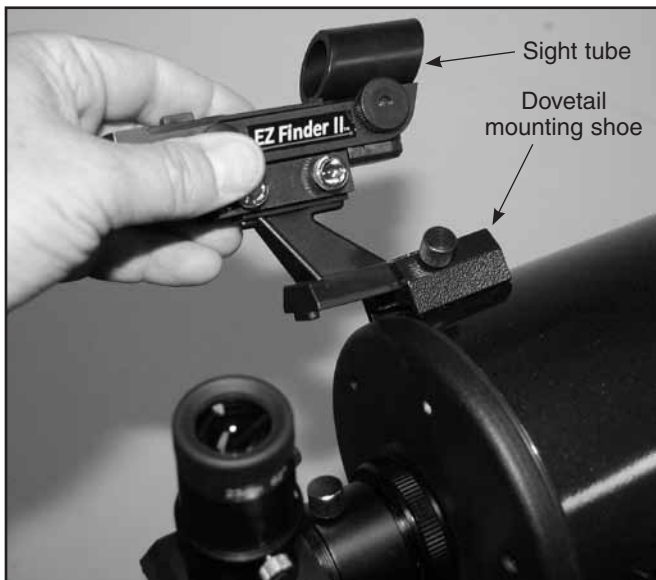
**Figure 11.** The EZ Finder II's On/Off and adjustment knobs.

## Learning to Use the EZ Finder, Eyepieces, and Focuser

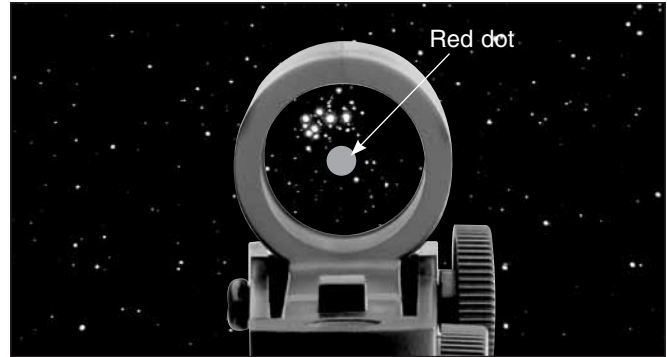
### The EZ Finder II

The EZ Finder II works by projecting a tiny red dot (it is not a laser beam) onto a lens mounted in the front of the unit. When you look through the EZ Finder II, the red dot will appear to float in space, helping you to pinpoint your target object (**Figure 13**). The red dot is produced by a light-emitting diode (LED) near the rear of the sight. The 3V lithium battery provides the power for the diode.

For the EZ Finder II to work properly, it has to be aligned with the telescope. When the two are aligned, a celestial object that is centered on the EZ Finder II's red dot should also appear in the center of the telescope's eyepiece. Alignment of the EZ Finder II is easiest during daylight, before observing at night. Aim the telescope at a distant object such as a telephone pole or roof chimney and center it in the telescope's eyepiece. The object should be at least 1/4 mile away. Now turn on the EZ Finder II and look through it. Without moving the main telescope, use the EZ Finder II's azimuth (left/right) and altitude (up/down) adjustment knobs (see **Figure 11**) to position the red dot on the object in the eyepiece. When the red dot is centered on the distant object, check to make sure that the object is still centered in the telescope eyepiece. If it isn't, re-center it and adjust the EZ Finder II's alignment again. When the object is centered in the eyepiece and on the EZ Finder's red dot, the EZ Finder II is properly aligned with the telescope. Once aligned, EZ Finder II will usually hold its alignment even after being removed and remounted. Otherwise, only minimal realignment will be needed.



**Figure 12.** Insert the EZ Finder II into its dovetail shoe in the orientation shown and secure it with the thumbscrew.



**Figure 13.** The EZ Finder II superimposes a tiny red dot on the sky, showing right where the telescope is aimed..

Turn the ON/OFF knob (see **Figure 11**) clockwise until you hear the “click” indicating that power has been turned on. Look through the back of the reflex sight with both eyes open to see the red dot. Position your eye at a comfortable distance from the back of the sight. In daylight you may need to cover the front of the sight with your hand to be able to see the dot, which is purposefully quite dim. The intensity of the dot is adjusted by turning the ON/OFF knob. For best results when stargazing, use the dimmest possible setting that allows you to see the dot without difficulty. Typically a dimmer setting is used under dark skies and a brighter setting is needed under light-polluted skies or in daylight.

At the end of your observing session, be sure to turn off the ON/OFF knob on the EZ Finder II

### Eyepieces and Magnification

Your StarSeeker IV telescope comes with two special wide-field eyepieces, which have a 60-degree field of view (**Figure 14**). Eyepieces are commonly referred to by their focal length



**Figure 14.** StarSeeker IV telescopes come with 23mm and 10mm wide-field eyepieces.





**Figure 15.** The StarSeeker IV mount is powered by eight user-supplied AA batteries, which are installed in the mount arm.

and barrel diameter. The focal length of each eyepiece is typically printed on the eyepiece body. The two eyepieces included with your telescope have a 1.25" barrel diameter. One has a focal length of 23mm and the other, 10mm. The longer the focal length (i.e., the larger the number), the lower the eyepiece power or magnification; and the shorter the focal length (i.e., the smaller the number), the higher the magnification. Generally, low or moderate power will produce the sharpest images when viewing.

You can change the magnifying power of your telescope just by changing the eyepiece (ocular). To determine the magnification of your telescope, simply divide the focal length of the telescope by the focal length of the eyepiece used.

$$\frac{\text{Telescope Focal Length (mm)}}{\text{Eyepiece Focal Length (mm)}} = \text{Magnification}$$

For example, the StarSeeker IV 114mm reflector has a focal length of 500mm, which when used with the supplied 23mm eyepiece yields 22x magnification:

$$\frac{500\text{mm}}{23\text{mm}} = 22\text{x}$$

The magnification provided by the 10mm eyepiece is:

$$\frac{500\text{mm}}{10\text{mm}} = 50\text{x}$$

Although the power can be varied, each instrument under average skies has a limit to the highest useful magnification that can be achieved. The general rule is 2x per millimeter of aperture is as high as you can reasonably go (with optional eyepiece and possibly a Barlow lens). For example, the StarSeeker IV 114mm reflector has a primary mirror that's 114mm in diameter. So 114mm times 2x per millimeter = 114

x 2 = 228. Thus, 228x is the highest useful magnification one can normally achieve under ideal seeing conditions with this telescope. (Trying to go higher would likely just result in dim, blurry images.) Although this is the maximum useful magnification, most observing will yield best results at lower powers.

### Focusing

To focus, if you have a StarSeeker IV Newtonian reflector or refractor telescope, simply turn either of the two focus wheels on the focuser until the image looks sharp. For the Maksutov-Cassegrain models, the focus knob resides to the right of the visual back, or accessory adapter. Make sure you're aimed at something far off in the distance. If you don't see an image at first, keep turning the focus knob in one direction while looking through the eyepiece; if you reach the end of the focuser travel start turning the focus knob in the other direction. Eventually, you should see the object you're aimed at come into view. After going just past the focus point in one direction, and then in the other direction, you will then be able to home in on the exact focus point using progressively smaller turns of the focus knobs.

### Image Orientation

For astronomical telescopes, the image orientation in the eyepiece will usually be different from the orientation you would see with the naked eye. Refractor and Maksutov-Cassegrain telescopes used with a standard 90-degree "star diagonal" will provide a right-side-up but backwards (mirror-reversed) image. For reflector telescopes the image in the eyepiece will appear



**Figure 16** The electronic ports for the hand controller and an optional 12V DC battery are located at the base of the mount arm. The SNAP port allows control of a DSLR camera when used with proper cable.

upside down or rotated to some degree. This is normal! For astronomical viewing image orientation is not critical because, after all, there's no "right side up" in space. But if you're planning to use your telescope also for terrestrial viewing, you may want to purchase a "correct-image" diagonal, which will produce a correctly oriented, right-side-up view. Reflector telescopes are not recommended for terrestrial viewing.

## Powering the StarSeeker IV Mount

Your StarSeeker IV mount can be powered by 8 user-supplied AA alkaline batteries inserted into the battery compartment located in the mount arm (see **Figure 15.**) (Note that the battery holder must be removed from the compartment to install four AA batteries on the back side). Alternatively, you can run the mount with an optional AC-to-DC adapter or a 12V DC field battery such as the Orion Dynamo Pro. A DC car-lighter style cable is provided with your telescope to connect a 12V field battery to your mount. Insert the plug of the DC cable into the "Power" jack located on the mount arm (**Figure 16**).

Toggle the power switch to the ON ( — ) position. The LCD on the StarSeeker's hand controller will immediately light up and display the opening message. To turn the StarSeeker IV mount off, toggle the power switch to OFF ( O ).

## The SynScan GoTo Hand Controller

The "command center" of the StarSeeker telescope is the SynScan V4 GoTo hand controller (**Figure 17**). In conjunction with the precision servo motors built into the mount, as well as the two optical encoders in each axis, the user-friendly SynScan controller allows automated, pinpoint slewing of the telescope to any celestial object in its 42,900-object database, saving you the trouble of manually searching for them. You can even tour a pre-selected list of the finest showpiece objects visible in tonight's sky with just a few button pushes. Once your target object has been acquired, the mount tracks its motion across the sky to keep it in the field of view.

### Keypad Layout and Connection Ports

The hand controller's two-line liquid crystal display (LCD) is backlit for comfortable viewing. The contrast of the text and the brightness of the red backlight are both adjustable.

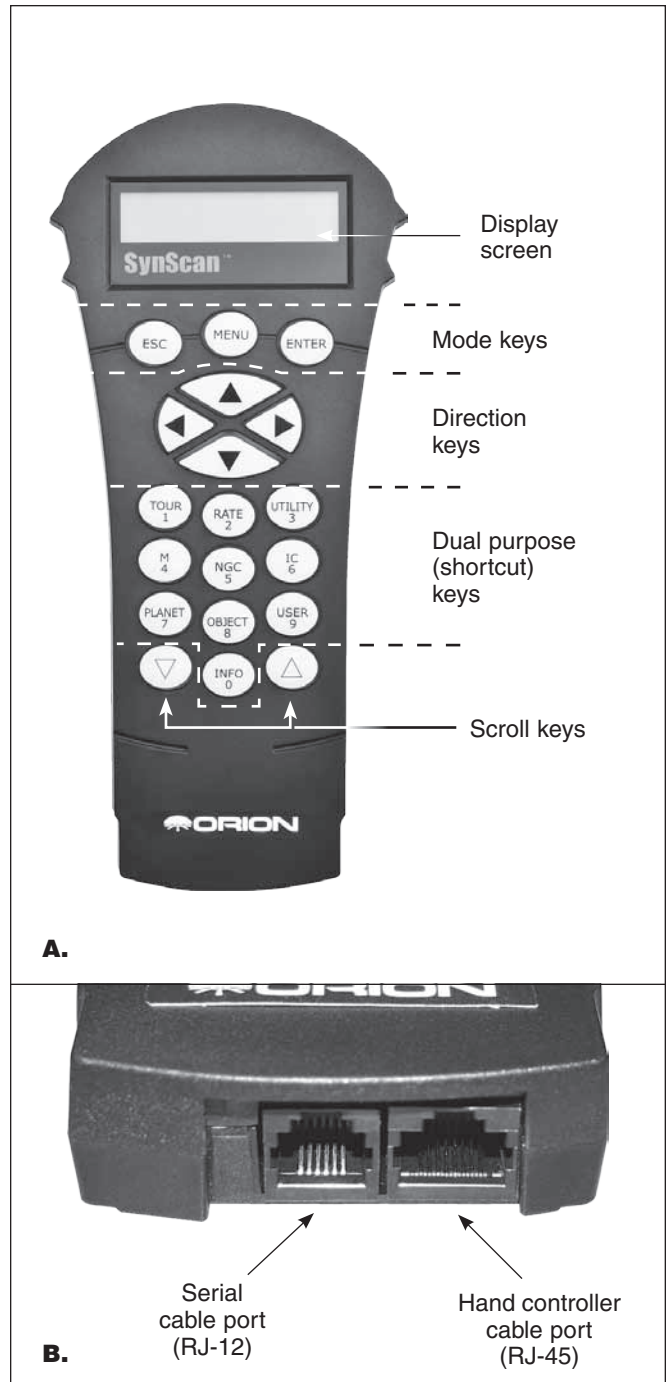
There are four categories of control keys on the hand controller (**Figure 17A**):

- 1) Mode keys
- 2) Directional keys
- 3) Scroll keys
- 4) Dual Purpose keys

### Mode Keys

The three mode keys are ESC, ENTER, and MENU.

- ESC is used to escape from a certain command or go back a level in the menu tree.

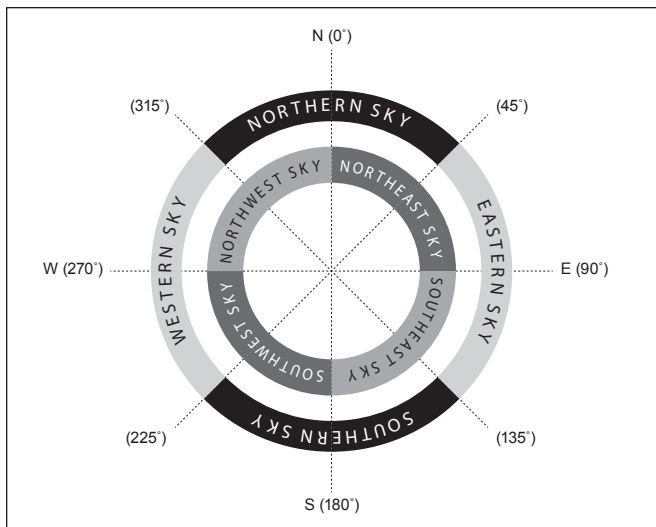


**Figure 17. A)** The SynScan V4 GoTo hand controller, **B)** Hand controller cable port and serial cable port on the bottom end of the controller.

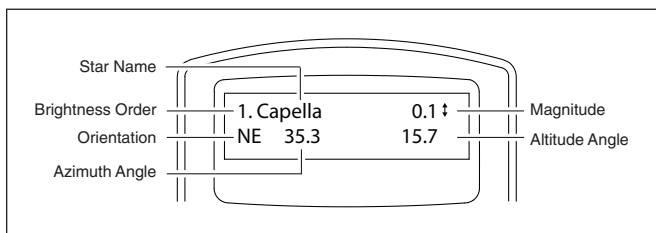
- MENU is a quick hot key that takes you to the Setup submenu.
- ENTER is used to select the functions and submenus in the menu tree, and to confirm certain functional operations.

### Direction Keys

The direction keys (Up, Down, Left, Right) allow the user to have complete control of the mount at almost any step in



**Figure 18.** Directional regions of the sky used in the “Brightest Star” alignment method.



**Figure 19.** Alignment star information displayed on LCD.

operation. These controls are locked out when the telescope is slewing to an object. The direction keys are very helpful when initially aligning the mount, centering objects in the eyepiece field of view, slewing, and manually guiding. The left and right direction keys can also be used to move the text cursor when entering data on the hand controller.

### Scroll Keys

The Up and Down scroll keys allow you to scroll up and down within the menu tree or selections displayed on the hand controller screen.

### Dual Purpose (Shortcut) Keys

The Dual Purpose keys serve two distinct purposes. They are used for data entry and as quick-reference (shortcut) keys.

- **TOUR:** Takes you on a preset tour of the best night sky objects visible
- **RATE:** Changes the speed of the motors when the directional buttons are pressed. There are 10 slew speeds to choose from, with 0 being the slowest and 9 being the fastest.
- **UTILITY:** Displays functions such as “Show Position”, “Display Time”... etc.
- **USER:** Gives access to up to 25 user-defined coordinates
- **INFO:** Identifies the object(s) the mount is currently pointing to

- **NGC, IC, M, PLANET, and OBJECT:** Allows direct access to database of thousands of objects

### Connecting the SynScan Hand Controller

Plug the larger of the two connectors on the coil cable into the RJ-45 jack on the bottom of the SynScan hand controller (**Figure 17B**).

Then plug the smaller connector into the RJ-12 port labeled “HC” at the base of the mount arm (**Figure 16**).

**NOTE:** The other, RJ-12 jack on the bottom of the hand controller is a serial port used for controlling the telescope via a computer running a compatible astronomy software program, or for updating the SynScan’s firmware.

## Initial Setup

1. **Power up.** Make sure the mount is level to the ground and the mount is powered on. The hand controller will issue a long beep and display the firmware version. Press ENTER
2. **Solar warning.** The hand controller will scroll a warning message about the danger of viewing the Sun with a telescope without a properly fitted solar filter. Press ENTER to confirm you have read the warning message and proceed to the next step.
3. **Set your location.** The LCD screen will display “Enter Location” on the first line, and longitude and latitude values on the second line. Enter the latitude and longitude of your current location using the numeric keypad and scroll buttons. If you do not know the latitude and longitude coordinates of your viewing location, consult an atlas or look them up on the internet (i.e., search “[your location] coordinates”). Use the scroll keys to choose between E or W (for longitude) and N or S (for latitude). Press ENTER to confirm the entered coordinates and proceed to the next step.

**NOTE: Latitude and longitude coordinates must be entered in degrees and arcminutes. If your atlas or other reference source provides coordinates in decimal values (i.e., latitude = 36.95 N), you must convert that into degrees and arcminutes (i.e., latitude 36.95 N = latitude 36°57' N). There are 60 arcminutes in 1 degree**

4. **Time zone.** Enter the current time zone in which you are observing in hours (see Appendix B), using the scroll keys and numeric keypad (+ for East, – for West) The “+” sign is used for time zones in the Eastern Hemisphere (Europe, Africa, Asia, Oceania), while the “-” sign is used for time zones in the Western Hemisphere (North and South America). So for Pacific Standard Time (PST) you would enter -08:00. Press ENTER to confirm. Enter the latitude and longitude of your current location using the numeric keypad and scroll buttons. If you do not know the latitude and longitude coordinates of your viewing location, consult an atlas or look them up on the internet (i.e., search “[your location] coordinates”).

## 5. Date, Time, Daylight Saving.

- Enter the date in the format mm/dd/yyyy using the numeric keypad. Press ENTER to confirm your choice.
- Enter your current local time using the 24 hour time mode (e.g., 2:00 p.m. = 14:00). Press ENTER to view the time you entered. If the time is incorrect, press ESC to go back to the previous screen. If the time is correct, press ENTER to confirm.
- When “Daylight Saving?” is displayed, use the scroll keys to select “Yes” or “No”. “YES” indicates the time entered in the previous step is Daylight Saving time, while “NO” indicates the time entered is Standard time. Press the ENTER key to confirm and proceed to the next step

6. **Start mount alignment.** Now the screen will display “Begin Alignment?” and ask you to select 1) YES or 2) NO. Press “1” or ENTER to start the alignment process. Press “2” or ESC to skip the alignment process. • When “Daylight Saving?” is displayed, use the scroll keys to select “Yes” or “No”. “YES” indicates the time entered in the previous step is Daylight Saving time, while “NO” indicates the time entered is Standard time. Press the ENTER key to confirm and proceed to the next step.

7. **Start mount alignment.** Now the screen will display “Begin Alignment?” and ask you to select 1) YES or 2) NO. Press “1” or ENTER to start the alignment process. Press “2” or ESC to skip the alignment process.

**NOTE: The hand controller LCD’s red illumination will dim and the keypad backlighting will turn off if idle for 30 seconds. Pressing any key turns the lighting back on.**

## Moving the Mount

One of the great features of StarSeeker IV telescopes that sets them apart from previous StarSeeker versions is the ability to move the mount by hand as well as electronically with the hand controller. That is, after the initial GoTo star alignment, the telescope can be moved by hand without losing the alignment. This can come in handy when slewing to target objects. For instance, if you know the object you want to observe is on the other side of the sky from where your telescope is currently pointed, you could move it most of the way there very quickly by hand, then use the hand controller to finish the precise pointing electronically using the GoTo command.

The directional keys (**Figure 17A**) allow you to move the mount in azimuth (left or right) and altitude (up or down). Just press the key corresponding to the direction you want the telescope to move; e.g., the top key to move the telescope upward or the right key to move the telescope to the right.

You can also quickly set or change the speed of movement. Pressing the (RATE/2) key will display the menu for choosing a slewing speed:

- The LCD screen displays “Set Speed”, followed by the current speed as “Rate = \*x”.

- Press a number between 0 and 9 to select a new speed.
- Press the ENTER key to confirm that new speed and return to the previous display.

If the ENTER button is not pressed, the selected speed will still be activated when you use the direction keys to slew the mount, if you do it within 5 seconds. However, if a directional key is not pressed within 5 seconds of selecting the speed, the previous speed will be kept.

## GoTo Star Alignment

In order for your StarSeeker IV GoTo telescope to accurately locate and point to objects in the sky, it must first be aligned on known positions (stars) in the sky. With that information, the mount can create a model of the sky and of the movements of astronomical objects.

There are two methods for aligning your StarSeeker IV telescope, and they are very similar: Brightest Star Alignment and 2-Star Alignment. Both involve identifying and pointing the telescope to two different bright stars in the night sky. Both alignment methods provide the same level of precision. The only difference is that for the Brightest Star alignment, the hand controller will prompt you to select the first alignment star from a directional region of the sky and will provide a short list of the brightest stars in that region. With the 2-Star alignment procedure the list of eligible stars is not grouped by region of sky.

For the novice stargazer unfamiliar with the night sky or the names of brighter stars, some might find the Brightest Star Alignment to be the easier of the two methods. The 2-Star method is for users who know the names of at least some stars in the night sky. To assist you in performing the alignment by either method, we have included in **Appendix C** a set of star charts with the names of some bright alignment stars indicated for easy reference.

**Note: Before performing any of the alignment methods, be sure that your finder scope is precisely aligned with the telescope tube.**

### To get the most accurate star alignment:

- The two alignment stars you choose should be at least 60 degrees apart. (For reference, your fist held at arm’s length spans about 10 degrees.)
- The two stars should be roughly at the same altitude.
- Use a high-power eyepiece, such as the 10mm focal length eyepiece included with the StarSeeker IV.
- **When centering an alignment star in the eyepiece, always end the procedure by using the UP and RIGHT direction keys. (Very important!)**
- If there is overshoot when centering an alignment star in the eyepiece with the UP and RIGHT keys, use the LEFT or DOWN keys to pull the star back to the edge of the field of view and then use the RIGHT and UP keys to center the star again.

---

## Brightest Star Alignment

### Aligning the 1st Star

1. Select "Brightest Star" as your Alignment Method. Press ENTER.
2. The hand controller will prompt you to "Select Region." Referring to **Figure 18**, choose the region that corresponds with where you see the brightest star in the sky. There are eight overlapping regions to choose from, each covers a 90-degree span in azimuth. The direction you choose will only affect your alignment star selection; you will still be able to choose objects to view across the entire sky once the alignment is complete. Referring to the included compass may be helpful during this process. The red portion of the pointer points North, so orient the compass so that the "N" (0 degrees) is directly under the red tip.
3. After you have selected a region of the sky, the hand controller will generate a list of the brightest stars in that region. Only stars or planets brighter than magnitude 1.5 will appear in the list, and only if they are between 10 and 75 degrees in elevation. If none is found meeting those criteria, the hand controller will display "No object found in this region." Press ENTER or ESC and select another region of sky.
4. Now, use the Scroll keys to scroll through the list of bright stars. There will only be a few stars, at most, on the list, and sometimes only one star. The hand controller will display the name and magnitude of the bright star on the first line, and its position on the second line (**Figure 19**). On the second line, the first number is the star's azimuth angle, or E-W coordinate, in degrees, and the second number is its altitude above the horizon in degrees. These coordinates provide a simple way to identify the bright star you have chosen. When you are confident the hand controller is displaying the name of the bright star you wish to align on, press ENTER.
5. **The mount will NOT slew to the first selected bright star automatically.** Instead, you will use the direction keys to slew the telescope to the 1st alignment star selected in the previous step. Center the 1st alignment star in the field of view of the EZ Finder II first, then center it in the telescope eyepiece. Press ENTER to proceed to the next step.

**NOTE: During this step the mount will select a medium speed for centering the star in the EZ Finder's field of view. If the mount is moving too slowly to the selected region you can move the mount manually. You could also change the speed as explained in the section Moving the Mount**

6. Now the screen will display "Ctr. to eyepiece" and the name of the selected 1st alignment star. The star should be inside the eyepiece field of view. Now use the direction keys to center it in the eyepiece and then press the (ENTER) key to proceed to the next step.

**NOTE: During this step the mount will select a slow speed allowing easy centering the star in the eyepiece**

**field of view. Don't move the mount manually, otherwise you will overshoot the star position and lose it. If the default speed is inadequate you can change it as described in the section Moving the Mount. Be sure to end the centering procedure by using the UP and RIGHT direction keys!**

### Aligning the 2nd Star

1. Once the first alignment star has been centered in the eyepiece, the SynScan will prompt you to "Choose 2nd Star." (If the first alignment "star" was actually a planet, you'll be prompted to re-select a first alignment star.) Scroll through the list using the Scroll keys and refer to the appropriate star chart in the back of this manual to choose a second alignment star, then press ENTER. The mount will now **automatically slew** toward the selected star, which should land in or near the field of view of the EZ Finder.
2. After the mount stops, the hand controller will give a long beep and display "Use dir. keys to center object." Don't worry if the star does not land in the center of the field of view – that's normal at this point. The mount is not yet fully aligned with the sky, after all. Center the star in the finder scope and then in the telescope's eyepiece, then press ENTER. If both alignment stars were properly aligned, the LCD will display "Alignment Successful." Press ENTER to complete the alignment process.

If the message "Alignment Failed" displays, it usually means the star positions do not correspond with the location and date/time information input during setup. Please check your user initialization settings before starting again.

3. After pressing (ENTER) to complete the alignment process the SynScan hand control will display the alignment menu again. Press the button (ESC) twice until the SynScan hand control displays CHOOSE MENU.

### Cancellation During Alignment Process

1. While the mount is slewing during the alignment, you may press the ESC key to stop the mount. The hand controller screen will display "Mount stopped. Press any key..."
2. Press any key and the SynScan hand controller will ask you to select another alignment star.
3. Press the ESC key again, and the LCD screen will display "Exit Alignment? 1) YES 2) NO." Press key 1 to exit the alignment process; press key 2 to go back to choose an alignment star.

### 2-Star Alignment

To perform the two-star alignment, follow the same steps described for the Brightest Star alignment, except that the hand controller will not prompt you to select a directional region for a bright star. Instead, you'll be presented with a list of stars available in your current sky to choose from, for each of the two alignment stars. Refer to the appropriate star chart in **Appendix C** to identify a star to select.

---

# Locating Objects

## SynScan's Object Database

The SynScan hand controller boasts a vast database of over 42,900 stars and other celestial objects. Once the telescope has been GoTo aligned, you can easily access and view any one of them. The database contains the following catalogs:

**Deep-Sky Tour:** Takes you on a preset tour across the night sky, stopping at the brightest and most beautiful deep-sky objects visible in your sky at the current time/date.

**Named Star:** A list of 100 popular, known stars

**Solar System:** The other 8 planets of our solar system (includes Pluto) and Earth's Moon

**NGC:** 7,840 of the brightest deep-sky objects from the Revised New General Catalog

**IC:** 5,386 of standard stars and deep sky objects from the Indexed Catalog

**Messier:** Complete list of 110 Messier objects

**Caldwell:** Complete list of 109 Caldwell objects

**SAO:** 29,523 stars brighter than magnitude 8, a small subset of the 259,000-star SAO catalog

**Double Stars:** 55 well-known double stars

**Variable Stars:** 20 famous variable stars

**User Objects:** Up to 25 user-defined objects can be saved

## Selecting an Object

There are several ways to select a celestial object to view. Many involve pressing one of the Dual Purpose, or Shortcut, keys on the hand controller (**Figure 17A**).

## Take a Guided Tour!

This is a great feature for backyard astronomers with minimal observing experience! The hand controller's built-in Deep Sky Tour feature commands the mount to find the best deep-sky objects in the currently visible sky and automatically slews the telescope to each one, at your prompt.

**TOUR** – The TOUR shortcut key takes you to the Deep Sky Tour submenu, where you can tour a preselected list of the best and brightest deep-sky objects in your current sky. Use the down scroll key to browse the objects. Choose an object by pressing **ENTER**. The display will show the coordinates of the chosen object. Pressing **ENTER** again will prompt the telescope to slew to the object, then track it.

You can also access the tour function from the SETUP menu, by scrolling to DEEP SKY TOUR and pressing ENTER.

## Select Using the Object Type Shortcut Keys

**M, NGC, IC** – These shortcut keys give you access to these popular celestial object catalogs. Use the numeric keys to select an object by entering its number. Pressing **ENTER** will display its coordinates. Pertinent information such as size, magnitude, and constellation are obtained by pressing the scroll keys. Pressing **ENTER** again will prompt the telescope to slew to the selected object, then track it.

**PLANET** – This shortcut key takes you to the Solar System submenu in the database. Use the scroll keys to cycle through the list of planets in our solar system (including Pluto!) and the Moon. Press **ENTER** to view an object's coordinates, and **ENTER** once more to slew to the object and track it.

**USER** – This key will take you to the database of User Objects that you can define for yourself. You can enter a new location or recall objects that have been previously saved (see "Saving and Accessing User-Defined Objects").

## Select Using the Object or Menu Shortcut Keys

**OBJECT** – The OBJECT key takes you to the Objects catalog, where you have complete access to over 42,900 celestial objects in the database.

**MENU** – Press the MENU key, then the ESC key and you will see CHOSE MENU:. Scroll down to OBJECT LIST and press ENTER. Similar to the OBJECT key, this gives you access to all 42,900 celestial objects in the database.

- If the selected object is below the horizon at this time, the SynScan hand controller will display "Below horizon" for 2 seconds; otherwise, it will display the object's current azimuth and altitude.
- By using the scroll keys, you can browse the following information of the object: J2000 celestial coordinates, magnitude (MAG= ), rising time (Rise: ), transit time (Transit: ), setting time (Set: ), size (Size= ) and associated constellation (Constellation: ).
- Once the mount has located the selected object, it will automatically start tracking it.
- You can press the ESC key to stop the mount if needed. The screen will display "Mount stopped. Press any key..." Then press any key to return to the previous step.

## NOTE: The mount will not slew if:

- The object is below the horizon.
- The object's altitude exceeds the limit set in the hand controller. (The screen will display "Target over slew limit" in this case.)

## Identifying an Unknown Object

After aligning the mount for GoTo operation, the SynScan hand controller can be used to identify any object at which the telescope is pointing.

1. Center the object to be identified in the telescope's eyepiece.
2. Press the "INFO" shortcut key, or from the CHOOSE MENU screen, scroll to "UTILITY FUNCTION" and press ENTER, then to IDENTIFY and press ENTER. The screen will display "Identify: Searching..." The SynScan hand controller will look up the named stars, planets, Messier objects, NGC objects, and IC objects within a 5 degrees range of the object centered in the eyepiece.
3. The screen will display "No object found" if the SynScan hand controller cannot identify the object.

4. If an object is found within the 5-degree range, the screen will display the object's name in the top row, and its distance from center of the eyepiece.
5. If multiple objects are found, use the scroll keys to browse through the list of identified objects.
6. Press the ENTER key to select an identified object and then use the scroll keys to read its data, such as the J2000 celestial coordinates, magnitude (MAG= ), rising time (Rise: ), transit time (Transit: ), setting time (Set: ), size (Size= ) and associated constellation (Constellation: ).
7. Press the ESC key to exit.

## Other Features & Functions

### Utility Functions

Utility functions are useful tools that are accessed by pressing the UTILITY key on the keypad.

**Show Position** – Displays the coordinates of the location where the telescope is currently pointed.

**Show Information** – Under this submenu, you may check local time, local sidereal time, hardware version, firmware version, and database version of the SynScan hand controller. If the hand controller is connected to the mount, this menu will also display the firmware version of the motor control (MC) board.

**Identify** – Identifies any object at and near which the telescope is pointing (see “Identifying an Unknown Object” above).

**Park Scope** – Moves the telescope to the Home position or parks the telescope at the current or previously stored parking position.

**PAE** – Pointing Accuracy Enhancement function. (See “Pointing Accuracy Enhancement” section below.)

**Clear PAE data** – Clears all PAE calibration data.

**GPS** – This allows you to obtain information from the optional SynScan GPS receiver.

**PC Direct Mode** – Allows the SynScan hand controller to work with a personal computer. Under this mode, the hand controller becomes a repeater between the PC and the telescope mount. The software running on the PC controls the mount directly (see “Controlling Your StarSeeker III via Computer and Astronomy Software”). PC direct mode is also used to update the motor controller's firmware (see “Updating Firmware”).

**Polarscope LED** – Not applicable to StarSeeker III.

**PEC Training** – Not applicable to StarSeeker III.

**Camera Control** – Not applicable to StarSeeker III.

### Setup Functions

The Setup functions allow you to change any system variable or information regarding location, time, date, and alignment configurations. To access the Setup Functions, either press MENU key on the keypad or scroll to SETUP under menu

option using the scroll keys. Below are the different functions available to you, and their purposes.

**Date** – Allows you to change the date entered at the initial setup.

**Time** – Allows you to change the current time.

**Observing Site** – Allows you to change your current location.

**Daylight Saving** – Allows you to turn On or Off Daylight Saving Time.

**Alignment** – Allows you to perform the GoTo star alignment.

### Alignment Stars

**Adv. Filter** – When this option is chosen, the hand controller will filter out any stars not suitable for star alignment.

**Sort by** – This allows the hand controller to generate a list of alignment stars and display them alphabetically or by their magnitude.

**Backlash** – Not applicable to StarSeeker III.

### Tracking

**Sidereal Rate**: This activates tracking in Sidereal rate (for viewing stars and deep-sky objects).

**Lunar Rate**: This activates tracking in Lunar rate (for viewing the Moon).

**Solar Rate**: This activates tracking in Solar rate (for viewing the Sun).

**Stop Tracking**: This stops the tracking instantly.

**Elevation Limits** – Allows you to set a slew limit for the mount's altitude axis, causing it to stop when it reaches the set altitude. Setting the slew limit prevents the optical tube from colliding with mount. The slew limit range will vary depending on the optical tube installed on the mount.

**Handset Setting** – This submenu allows adjustments of the brightness of the LCD backlight, the darkness of the LCD text, the brightness of the button backlighting, and the beeper volume. Press the RIGHT or LEFT directional key to increase or decrease the value.

**Factory Setting** – This submenu allows you to reset the hand controller to its default setting.

### Updating Firmware

From time to time the internal software (firmware) of the SynScan hand controller may be upgraded to add new features and/or to fix bugs. You can find the latest firmware version on Orion's website and easily update the hand controller.

Refer to the page on our website ([www.OrionTelescopes.com](http://www.OrionTelescopes.com)) for your particular telescope and click on the Product Support icon. There you will find the instructions and files for updating the SynScan firmware.

## Collimation of StarSeeker IV Reflectors

CCollimation is the process of adjusting the telescope's optical elements so they are aligned with one another and with the

---

optical tube. Well collimated optics are critical for achieving the sharpest possible images with your telescope. Precise collimation of StarSeeker IV telescopes is done at the factory, and for the StarSeeker IV refractor and Maksutov-Cassegrains, it should never need any further adjustment. For reflectors, on the other hand, occasional collimation of the mirrors may be necessary.

For details on the collimation procedure for the StarSeeker IV 114mm and 130mm reflectors, refer to the page on our website ([www.OrionTelescopes.com](http://www.OrionTelescopes.com)) for your particular telescope and click on the Product Support icon. There you will find collimation instructions.

Note that the StarSeeker IV reflectors come with a “quick collimation cap” (shown in **Figure 2**), which is used in the collimation procedure. Also, you’ll notice that the primary mirror of the StarSeeker IV reflector has a tiny ring (sticker) marking its center. This “center mark” allows you to achieve a very precise collimation; you don’t have to guess where the exact center of the mirror is.

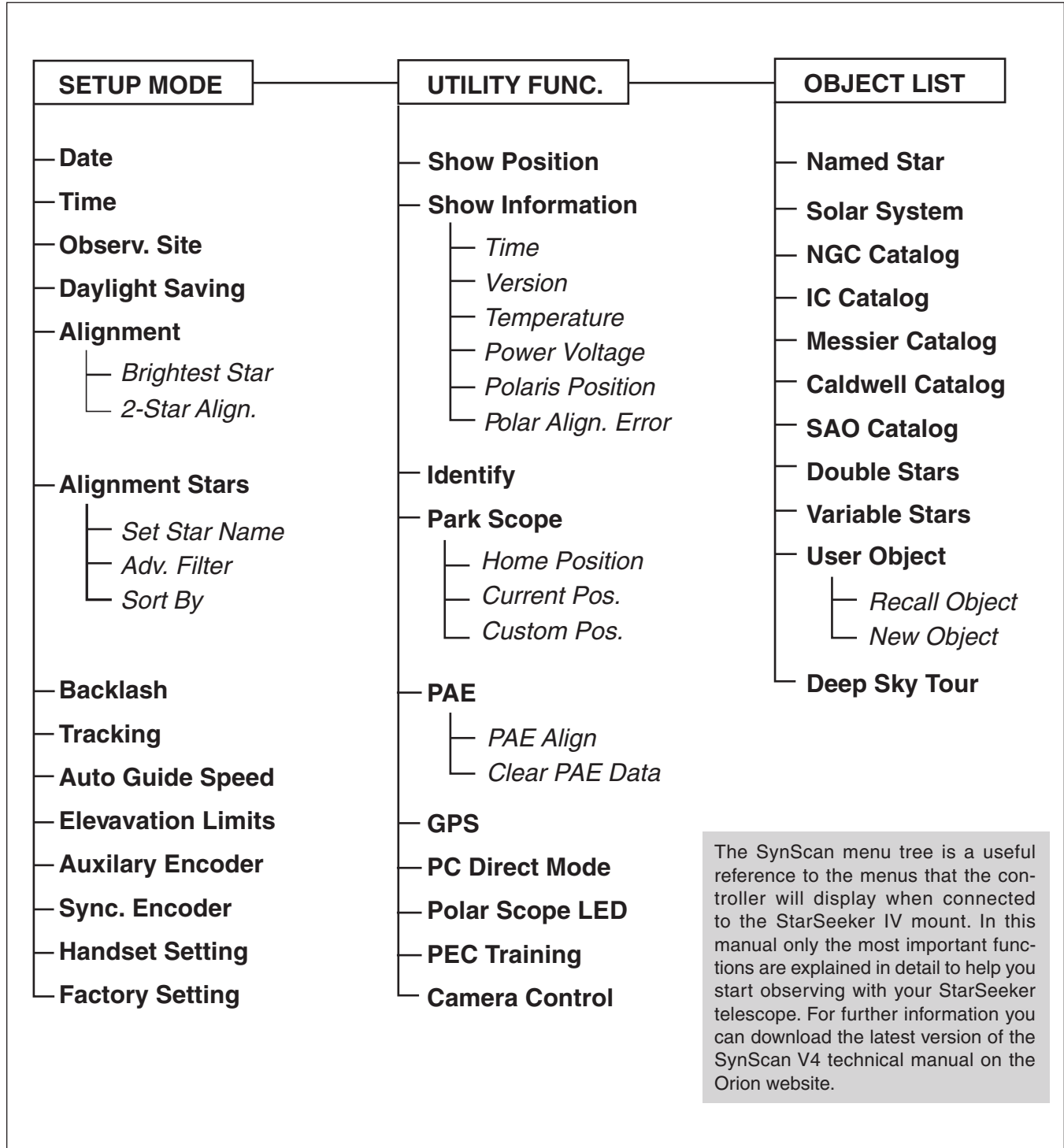
***NOTE: The center ring sticker need not ever be removed from the primary mirror. Because it lies directly in the shadow of the secondary mirror, its presence in no way adversely affects the optical performance of the telescope or the image quality. That might seem counter-intuitive, but it's true!***



# Appendix A – SynScan Menu Tree

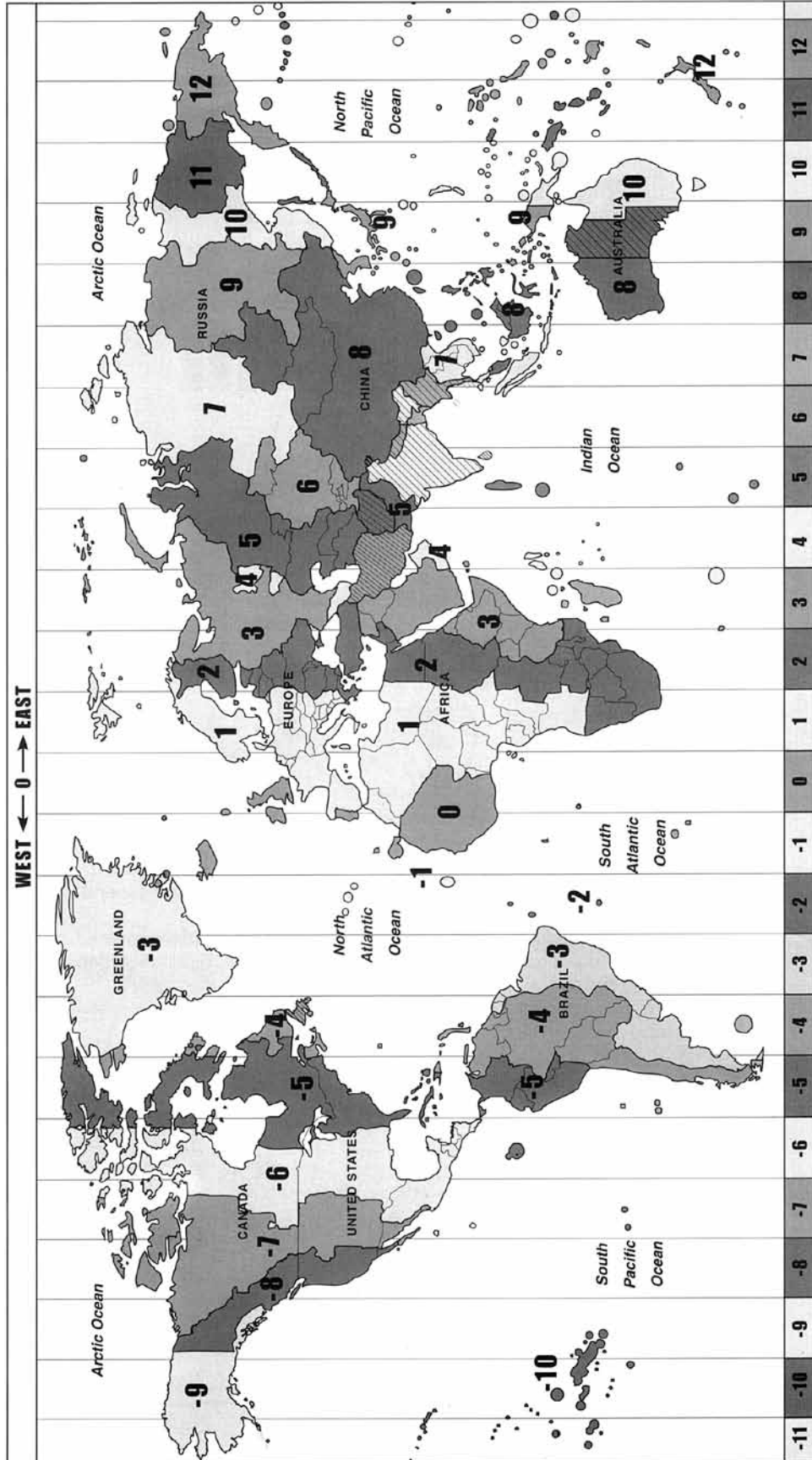
## Accessing Menus

The SynScan hand controller's menu is only accessible after the initialization, or after the GoTo alignment routine is completed (if it is chosen at startup). Users can use the ESC key, the ENTER key, and the two scrolling keys to access the menu.

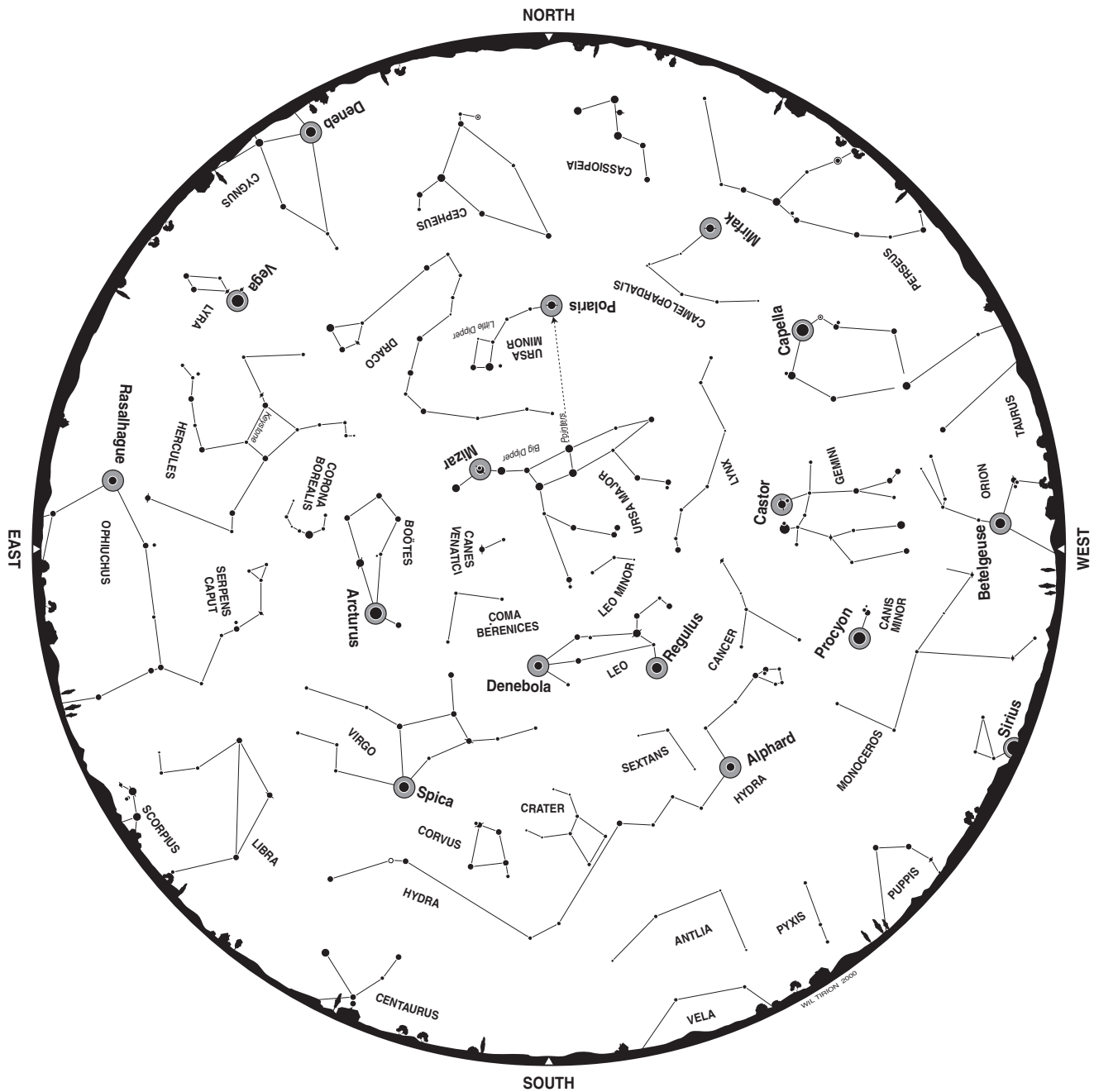


The SynScan menu tree is a useful reference to the menus that the controller will display when connected to the StarSeeker IV mount. In this manual only the most important functions are explained in detail to help you start observing with your StarSeeker telescope. For further information you can download the latest version of the SynScan V4 technical manual on the Orion website.

# Appendix B – Time Zone Map



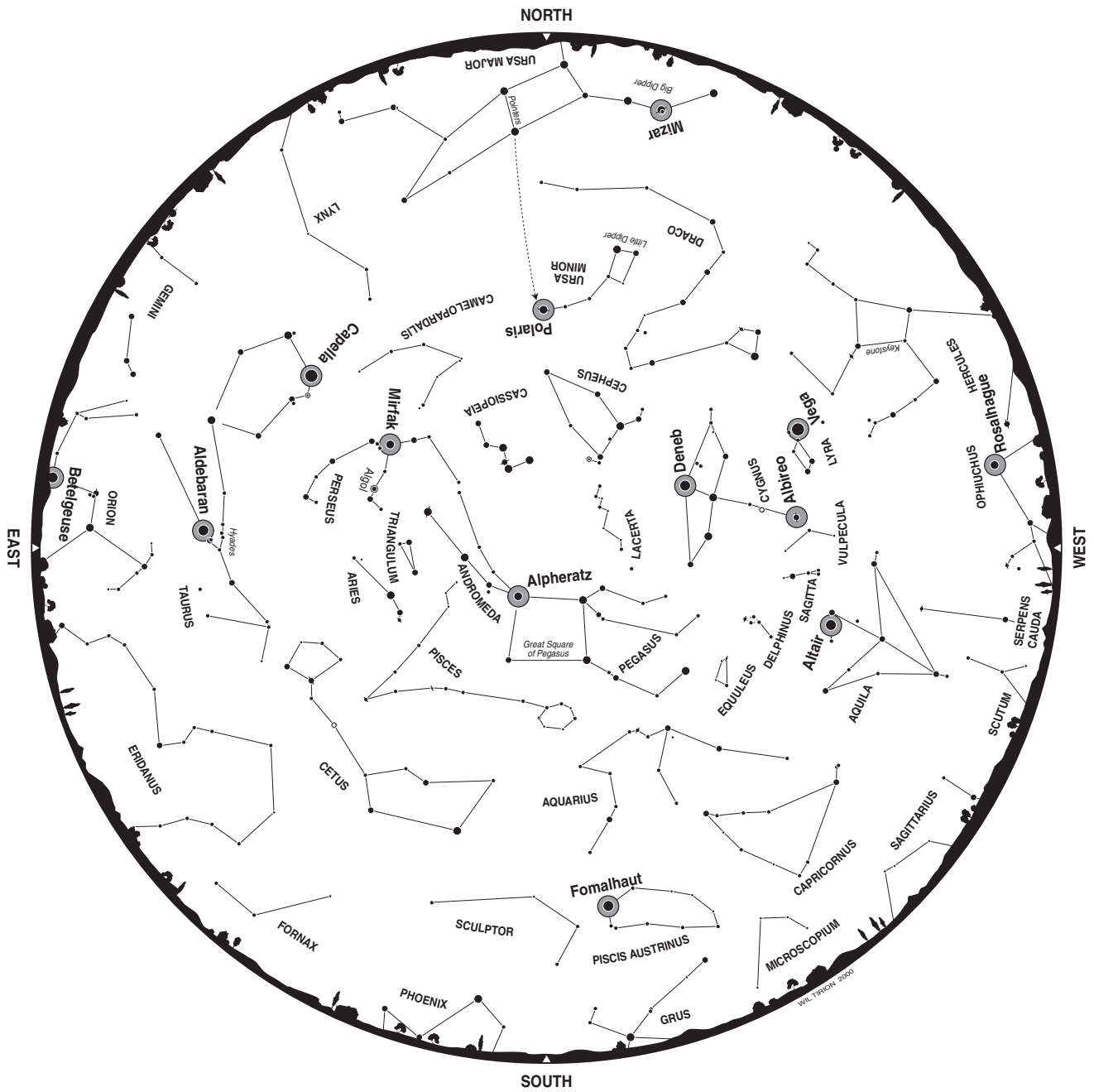
# Appendix C – Sky Maps (for selection of alignment stars)



SPRING	
Early March	1:00 AM
Late March	12:00 AM
Early April	12:00 AM*
Late April	11:00 PM*
Early May	10:00 PM*
Late May	9:00 PM*
Early June	8:00 PM (dusk)*

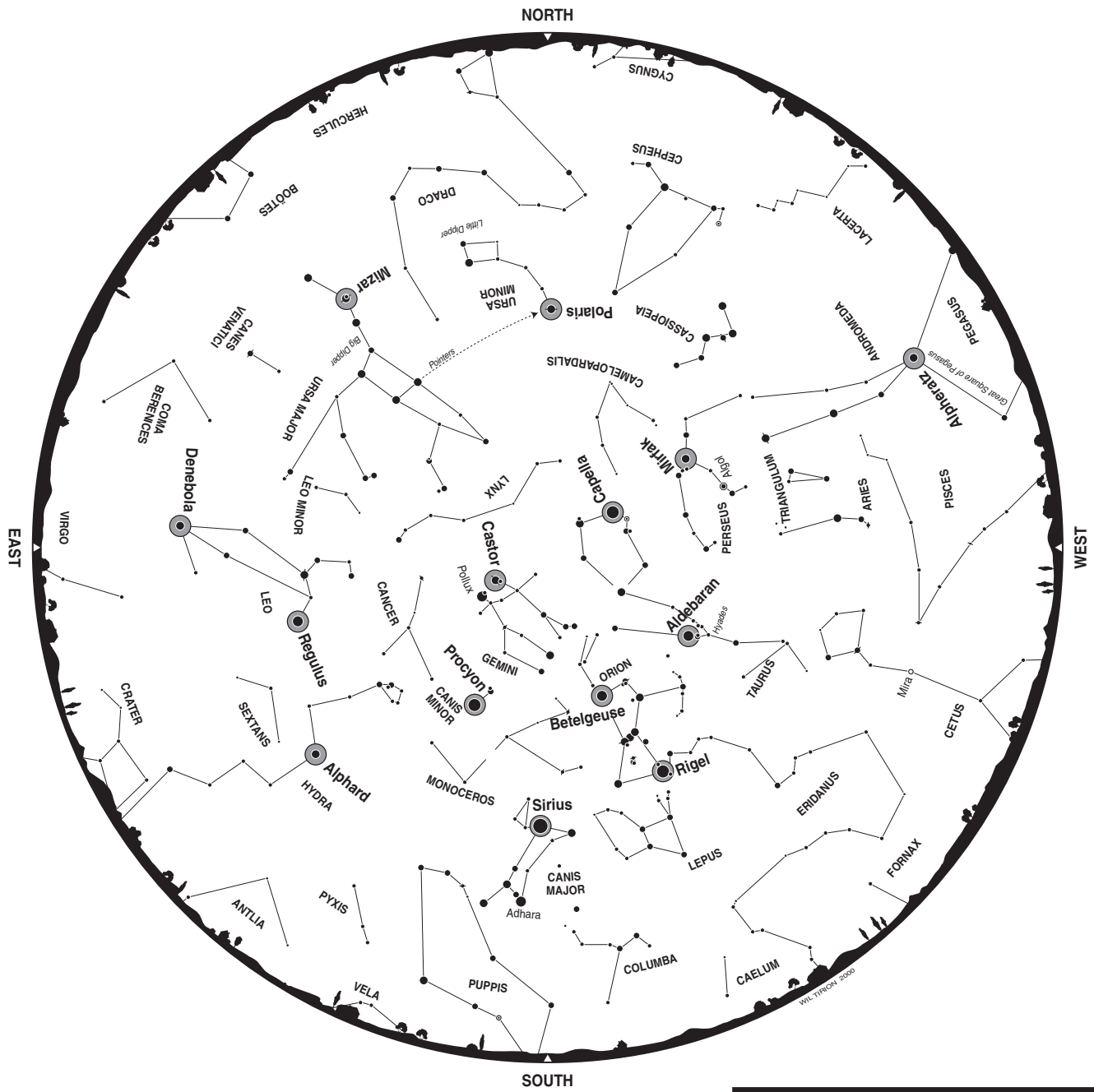
\*Daylight saving time





AUTUMN	
Early September	2:00 AM*
Late September	1:00 AM*
Early October	12:00 AM*
Late October	11:00 PM*
Early November	9:00 PM
Late November	8:00 PM
Early December	7:00 PM

\*Daylight saving time



WINTER	
Early December	2:00 AM
Late December	1:00 AM
Early January	12:00 AM
Late January	11:00 PM
Early February	10:00 PM
Late February	9:00 PM
Early March	8:00 PM



---

## **One-Year Limited Warranty**

This Orion product is warranted against defects in materials or workmanship for a period of one year from the date of purchase. This warranty is for the benefit of the original retail purchaser only. During this warranty period Orion Telescopes & Binoculars will repair or replace, at Orion's option, any warranted instrument that proves to be defective, provided it is returned postage paid. Proof of purchase (such as a copy of the original receipt) is required. This warranty is only valid in the country of purchase.

This warranty does not apply if, in Orion's judgment, the instrument has been abused, mishandled, or modified, nor does it apply to normal wear and tear. This warranty gives you specific legal rights. It is not intended to remove or restrict your other legal rights under applicable local consumer law; your state or national statutory consumer rights governing the sale of consumer goods remain fully applicable.

For further warranty information, please visit [www.OrionTelescopes.com/warranty](http://www.OrionTelescopes.com/warranty).

### **Orion Telescopes & Binoculars**

**89 Hangar Way, Watsonville CA 95076**

**Customer Support Help Line (800) 676-1343 • Day or Evening**

© Copyright 2015 Orion Telescopes & Binoculars